

WE 170 V

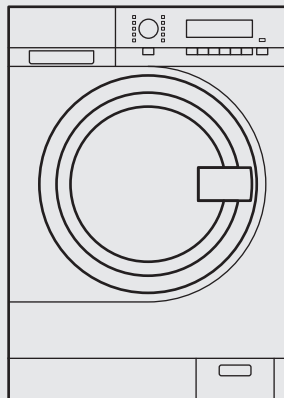

EN User Manual

Washing Machine



Electrolux

CAUTION: Read the instructions before using the appliance. Original Instructions.

CONTENTS

| | |
|---------------------------------|----|
| 1. SAFETY INFORMATION..... | 2 |
| 2. PRODUCT DESCRIPTION..... | 7 |
| 3. BEFORE FIRST USE..... | 9 |
| 4. CONTROL PANEL..... | 9 |
| 5. PROGRAMMES | 11 |
| 6. CONSUMPTION VALUES..... | 14 |
| 7. OPTIONS..... | 15 |
| 8. SETTINGS..... | 15 |
| 9. DAILY USE..... | 16 |
| 10. HINTS AND TIPS..... | 20 |
| 11. CARE AND CLEANING..... | 21 |
| 12. TROUBLESHOOTING..... | 23 |
| 13. EMERGENCY DOOR OPENING..... | 25 |
| 14. TECHNICAL DATA..... | 26 |

WE'RE THINKING OF YOU

Thank you for purchasing an Electrolux appliance. You've chosen a product that brings with it decades of professional experience and innovation. Ingenious and stylish, it has been designed with you in mind. So whenever you use it, you can be safe in the knowledge that you'll get great results every time.

Welcome to Electrolux.

CUSTOMER CARE AND SERVICE

Always use original spare parts.

When contacting our Authorised Service Centre, ensure that you have the following data available: Model, PNC, Serial Number.

The information can be found on the rating plate.

 Read the instructions before using the appliance

 Warning / Caution-Safety information

 General information and tips

 Environmental information

Subject to change without notice.

1. SAFETY INFORMATION

Before the installation and use of the appliance, carefully read the supplied instructions. The manufacturer is not responsible if an incorrect installation and use causes injuries and damages. Always keep the instructions with the appliance for future reference.

1.1 Children and vulnerable people safety

- This appliance can be used by children aged from 8 years and above and persons with reduced physical, sensory or mental capabilities or lack of experience and knowledge if they have been given supervision or instruction concerning use of the appliance in a safe way and understand the hazards involved.
- Children less than 3 years of age should be kept away unless continuously supervised
- Do not let children play with the appliance.
- Keep all packaging away from children.
- Keep all detergents away from children.
- Keep children and pets away from the appliance door when it is open.
- Cleaning and user maintenance shall not be made by children without supervision.

1.2 Installation

- Obey the installation instruction supplied with the appliance.
- Make sure that the appliance is stable during transportation.
- Make sure that the appliance is disconnected from the electricity supply during installation, maintenance and repairs and cannot be reconnected until all work has been carried out.
- Remove all the packaging and the transit bolts.
- Keep the transit bolts. When you move the appliance again you must block the drum.
- Always be careful when you move the appliance because it is heavy. Always wear safety gloves.
- This appliance is for indoor use only.
- Do not install or use a damaged appliance.
- Do not install or use the appliance where there is risk of freezing or where it is exposed to the weather (e.g. directly to the sunlight, humid and dusty location).

- Make sure that all health and safety regulations are obeyed when the appliance is installed in a commercial/public environment.
- Make sure that the floor where you install the appliance is flat, stable, heat resistant and clean.
- Make sure that there is air circulation between the appliance and the floor.
- The ventilation openings in the base (if applicable) must not be obstructed by a carpet.
- Adjust the feet to have the necessary space between the appliance and the carpet.
- Do not install the appliance where the appliance door can not be fully opened.

1.3 Electrical Connection

- The appliance must be correctly earthed. The manufacturer is not responsible for the consequences of an inadequate earthing system.
- Always use a correctly installed shockproof socket.
- Make sure that the electrical information on the rating plate agrees with the power supply. If not, contact an electrician.
- Do not use multi-plug adapters and extension cables.
- Make sure not to cause damage to the mains plug and to the mains cable.
- If the supply cord is damaged, it must be replaced by the manufacturer, its Authorised Service Centre or similarly qualified persons in order to avoid a hazard.
- Connect the mains plug to the mains socket only at the end of the installation. Make sure that there is access to the mains plug after the installation.
- Do not touch the mains cable or the mains plug with wet hands.
- Do not pull the mains cable to disconnect the appliance. Always pull the mains plug.

- Only for UK and Ireland: The appliance has a 13 amp mains plug. If it is necessary to change the fuse in the mains plug, use a 13 amp ASTA (BS 1362) fuse.
- This appliance complies with the E.E.C. Directives.

1.4 Water connection

- Make sure not to cause damage to the water hoses.
- The appliance is to be connected to the water mains using the new supplied hose-sets. Old hose sets must not be reused.
- Before you connect the appliance to new pipes or pipes not used for a long time, let the water flow until it is clean.
- The operating water pressure (minimum and maximum) must be between 0,5 bar (0,05 MPa) and 8 bar (0,8 MPa).
- The first time you use the appliance, make sure that there is no leakage.

1.5 Use

- Do not change the specification of this appliance.
- Obey the safety instructions on the detergent packaging.
- Obey the maximum load volume of 8 kg (refer to the “Programme chart” chapter).
- Do not put flammable products or items that are wet with flammable products in, near or on the appliance.
- Make sure that you remove all metal objects from the laundry.
- Do not put a container to collect possible water leakage under the appliance. Contact the Authorised Service Centre to ensure which accessories can be used.
- Do not touch the glass of the door while a programme operates. The glass can be hot.

1.6 Care and cleaning

- Before maintenance, deactivate the appliance and

disconnect the mains plug from the mains socket.

- Do not use water spray and steam to clean the appliance.
- Clean the appliance with a moist soft cloth. Only use neutral detergents. Do not use abrasive products, abrasive cleaning pads, solvents or metal objects.

1.7 Internal light



WARNING!

Risk of injury.

- Visible LED radiation, do not look directly into the beam.
- The type of light bulb or halogen lamp used for this appliance is only for household appliances. Do not use it for house lighting.
- To replace the internal light, contact the Authorised Service Centre.

1.8 Service

- Only original spare parts can ensure the safety standards of the appliance.
- Only repairs undertaken by an Electrolux approved service technician are covered by the guarantee.

1.9 Disposal

- Disconnect the appliance from the mains supply.
- Cut off the mains cable and discard it.
- Remove the door catch to prevent children and pets to get closed in the appliance.

2. PRODUCT DESCRIPTION

2.1 Appliance overview

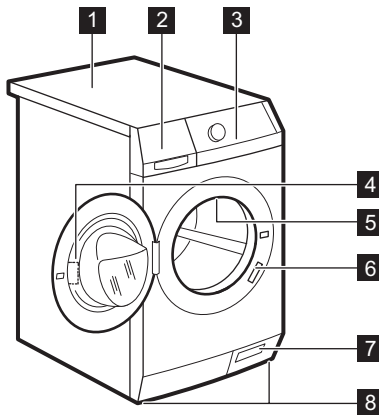

- 1 Worktop
- 2 Detergent dispenser
- 3 Control panel
- 4 Door handle
- 5 Internal light
- 6 Rating plate
- 7 Emergency door opening
- 8 Feet for the appliance level

2.2 Accessories

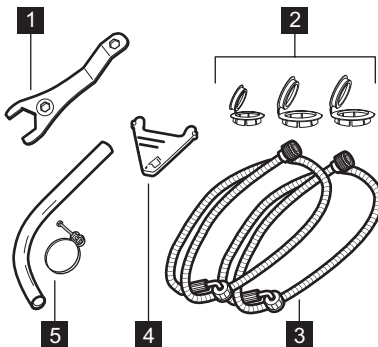

- 1 **Spanner**
To remove the transit bolts.
- 2 **Plastic caps**
To close the holes on the rear side of the cabinet after the removal of the transit bolts.
- 3 **Inlet hoses**
To connect the appliance to the cold and hot water tap: blue cap hose for cold water and red cap hose for hot water.
- 4 **Flap for liquid detergent**
To slow down the liquid detergent flow.
- 5 **Drain hose and clamp**
To connect the appliance to a drain system. Use the clamp to fix the drain hose tight. If necessary, the drain hose can be cut and shortened.

2.3 Available from your authorized vendor

- i** Only appropriate accessories approved by Electrolux ensure the safety standards of the appliance. If unapproved parts are used, any claims will be invalidated.

Stacking kit

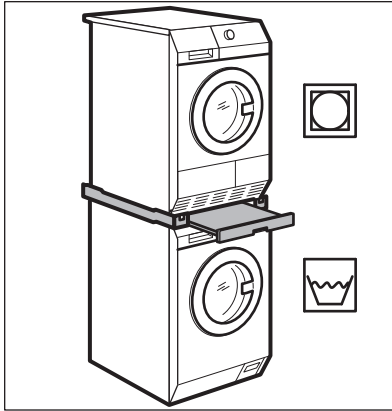

i Stacking kit can be used only with the tumble dryers specified in the leaflet. See the leaflet attached. Read carefully the instructions supplied with the accessory.

Pedestal with the drawer

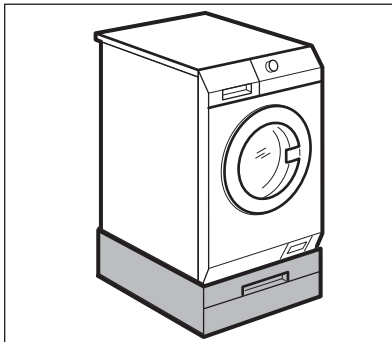

To put the appliance higher at the level what helps to easy load and remove the laundry.

The drawer can be used for laundry storage e.g.: towels, cleaning products and more.

Read carefully the instructions supplied with the accessory.

Anchoring kit

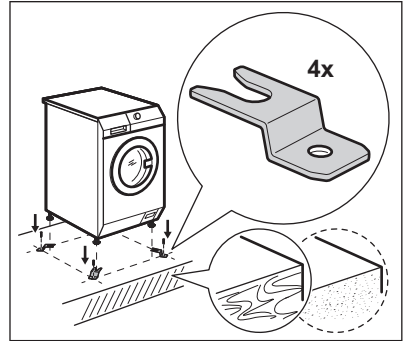

If you install the appliance on a concrete base, please make sure to order the correct anchoring kit.

Read carefully the instructions supplied with the accessory.

Coin operated machine

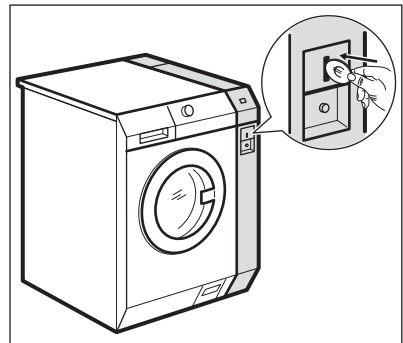

If the appliance is set in a public place, it can be connected to a coin operated machine.

Read carefully the instructions supplied with the accessory.

External detergent dispenser

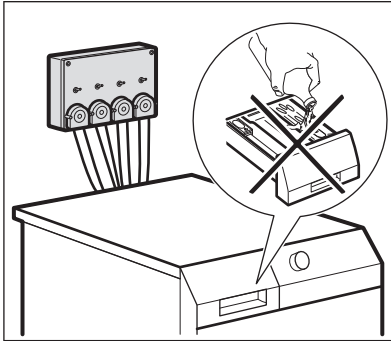

The liquid detergent can be loaded automatically from an external dispenser. Read carefully the instructions supplied with the accessory.

3. BEFORE FIRST USE

1. Make sure that all transit bolts are removed.
2. Make sure that the electrical and water connection are available.
3. Put a small quantity of detergent in the compartment for washing phase.
4. Set and start a programme for cotton at the highest temperature without laundry. This removes all possible dirt from the drum and the tub.

4. CONTROL PANEL

4.1 Control panel description

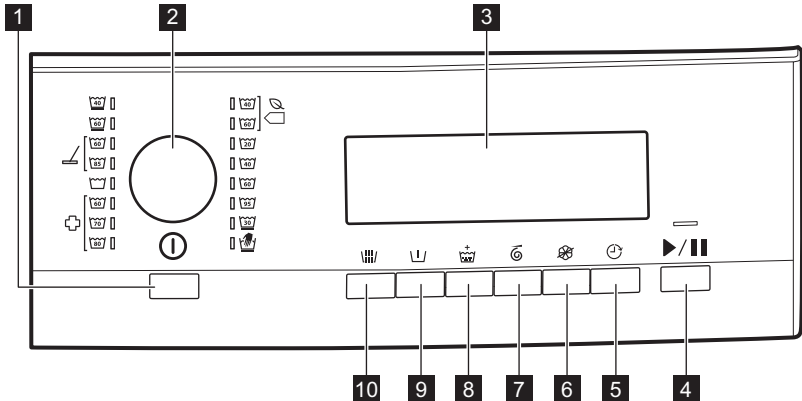







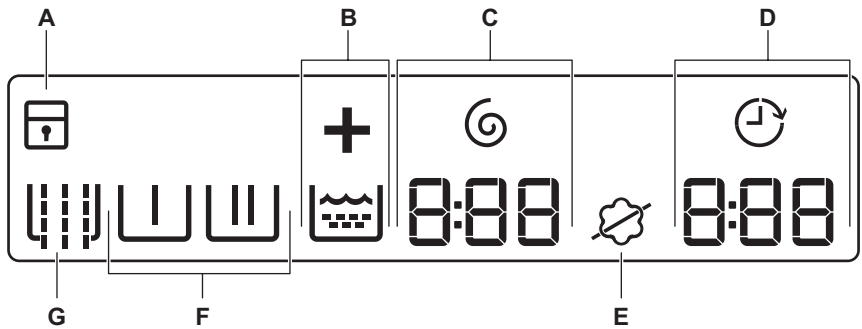



- | | |
|--|---|
| <ul style="list-style-type: none"> 1 Auto Off button 2 Programme knob 3 Display 4 Start/Pause button 5 Delay start button | <ul style="list-style-type: none"> 6 No softener button 7 Spin time button 8 Extra rinse button 9 Pre wash button |
|--|---|







10 Pre rinse button 

4.2 Display









The display shows:









| | | |
|----------|---|--|
| A |  | The child safety lock is activated. |
| |  | The child safety lock is deactivated. |
| B |  | Extra rinse symbol.  is the symbol indicating the rinse phase and + lights up when the Extra rinse is selected. |
| C |  | Spin time indicator and symbol. The digit indicates minutes and seconds. |
| D |  | Delay start indicator. |
| |  | Programme time When the programme starts, the programme time decreases with steps of 1 minute. The digit indicates hours and minutes. |
| |  | Delay start When you press the delay start button, the display shows the delay start time |
| |  | Alarm codes If the appliance has a malfunction, the display shows alarm codes. Refer to «Troubleshooting». |
| |  | The display shows this message for some seconds when: <ul style="list-style-type: none"> • you cannot set a function with the washing programme • you try to change the washing programme while it operates. |
| |  | When the programme is completed. |



| | | |
|---|---|---|
| E |  | Softener symbol: the appliance does load softener normally. |
| |  | No softener symbol: the appliance doesn't load softener. |
| The phase symbols | | |
| When a programme is set, all the symbols of the phases related to the programme come on. When the programme starts, only the symbol of the phase in operation flashes. When the phase is completed, the symbol remains steady lighted up. | | |
| F |  | Pre wash phase |
| |  | Washing phase |
| |  | Rinse phase |
| |  | Spin phase |
| G |  | Pre rinse symbol |

5. PROGRAMMES

5.1 Programme Chart

| Programme Temperature range 1) | Maximum load 2) Maximum spin speed Spin Time | Programme description (Type of load and soil level) |
|---|---|--|
|  Eco ³⁾  | 4 kg 1400 rpm 540 seconds - 5 seconds | White cotton and colour-fast cotton. Normal soil. The energy consumption decreases and the time of the washing programme is extended. |
|  Eco ³⁾  | 8 kg 1400 rpm 540 seconds - 5 seconds | White cotton and colour-fast cotton. Normal soil. The energy consumption decreases and the time of the washing programme is extended. |
| Normal    | 8 kg 1400 rpm 360 seconds - 5 seconds | White cottons Normal soil and light soil. ⁴⁾ |

| Programme Temperature range 1) | Maximum load 2) Maximum spin speed Spin Time | Programme description (Type of load and soil level) |
|--|---|--|
| Normal  | 8 kg 1400 rpm 360 sec- onds - 5 seconds | Coloured cottons Normal soil and light soil. ⁵⁾ |
| Delicates  | 4 kg 1200 rpm 120 sec- onds - 5 seconds | Delicate fabrics as acrylics, viscose, polyester items. Normal soil. |
|  Handwash  | 2 kg 1200 120 sec- onds - 5 seconds | Machine washable wool, hand washable wool and delicate fabrics with «hand washing» care symbol. ⁶⁾ |
| Synthetics  | 4 kg 1200 120 sec- onds - 5 seconds | Synthetic items or mixed fabric items. Normal soil. |
|  Mop  | 8 kg 1400 rpm 240 sec- onds - 5 seconds | Programme for mops, work wear and special programme for microfibres. The programme performs an automatic pre rinse phase. |
|  Rinse | 8 kg 1400 rpm 360 sec- onds - 5 seconds | To rinse and spin the laundry. All fabrics. |

| Programme Temperature range 1) | Maximum load 2) Maximum spin speed Spin Time | Programme description (Type of load and soil level) |
|--|---|---|
|  Disinfection  | 8 kg 1400 rpm 360 seconds - 5 seconds | This programme removes dust mites and similar micro-organisms. The programme performs an automatic pre wash phase. |

1) If connected, hot water is loaded only in the programme Eco, Normal, Synthetics, Mop and Disinfection when the set temperature is 40°C or higher.

2) For an optimal result, the maximum load indicated for each programme is recommended.

3) **Standard programmes for the Energy Label consumption values.** According to regulation 1061/2010, these programmes are respectively the «Standard 60°C cotton programme» and the «Standard 40°C cotton programme». They are the most efficient programmes in terms of combined energy and water consumption for washing normally soiled cotton laundry.









The water temperature of the washing phase may differ from the temperature declared for the selected programme.

4) A detergent with bleach should be used.

5) A detergent without bleach should be used.

6) During this cycle the drum rotates slowly to ensure a gentle washing. It can seem that the drum doesn't rotate or doesn't rotate properly. Consider this as a normal functioning of the appliance.

Programme options compatibility

| Programme |  |  |  |  |  |  |
|--|---|---|---|---|---|--|
| Eco  | ■ | ■ | ■ | ■ | ■ | ■ |
| Normal | ■ | ■ | ■ | ■ | ■ | ■ |
| Delicates 30°C | ■ | ■ | ■ | ■ | ■ | ■ |
| Handwash | ■ | | | ■ | ■ | ■ |
| Synthetics 40°-60°C | ■ | ■ | ■ | ■ | ■ | ■ |
| Mop | ■ 1) | | ■ | ■ | ■ | ■ |
| Rinse | | | ■ | ■ | | ■ |
| Disinfection | ■ | ■ 1) | ■ | ■ | ■ | ■ |

1) This option is automatically performed and cannot be removed from the programme.

6. CONSUMPTION VALUES



WARNING!

The highest hot water temperature allowed is 55°C.



The data of this table are approximate. Different causes can change the data: the quantity and type of laundry, the water and ambient temperature.



At programme start the display shows the duration programme for the maximum load capacity.

During the washing phase the programme duration is automatically calculated and can be greatly reduced if the laundry load is lower than the maximum load capacity (e.g. Cotton 60°C, maximum load capacity 8 kg, the programme duration exceeds 2 hours; real load 1 kg, the programme duration don't reach 1 hour).

When the appliance is calculating the real programme duration a dot blinks in the display.

| Programmes | Load (kg) | Water supply | Energy consumption (kWh) | Water consumption (litre) | Approximate programme duration (minutes) | Remaining moisture (%) ¹⁾ |
|-----------------------------------|-----------|--------------|--------------------------|---------------------------|--|--------------------------------------|
| Normal 60 °C | 8 | Hot and cold | 0,60 | 62 | 70 | 49 |
| Normal 40 °C | 8 | Hot and cold | 0,20 | 62 | 63 | 49 |
| Synthetics 40 °C | 4 | Hot and cold | 0,08 | 31 | 55 | 35 |
| Delicates 30 °C | 4 | Cold | 0,20 | 49 | 47 | 35 |
| Handwash 40 °C | 2 | Cold | 0,33 | 48 | 45 | 30 |
| Standard cotton programmes | | | | | | |
| Standard 60 °C cotton | 8 | Cold | 0,87 | 51 | 209 | 49 |
| Standard 60 °C cotton | 4 | Cold | 0,65 | 44 | 162 | 49 |
| Standard 40 °C cotton | 4 | Cold | 0,48 | 44 | 160 | 49 |

¹⁾ At the end of spin phase.

| Off Mode (W) | Left On Mode (W) |
|--|------------------|
| 0,05 | 0,05 |
| The information given in the chart above are in compliance with the EU Commission regulation 1015/2010 implementing directive 2009/125/EC. | |

7. OPTIONS

7.1 Pre rinse

Press this button to add a pre rinse phase without detergent before washing.

The related indicator comes on .

7.2 Pre wash

With this option you can add a prewash phase to a washing programme.

Use this option for heavy soil.

When you set this option the programme duration increases.

The related indicator comes on .

7.3 Extra rinse

With this option you can add some rinses to a washing programme.

Use this option for persons allergic to detergents and in areas where the water is soft.

The related indicator comes on .

7.4 Spin time

By pressing this button you can decrease the spin time. Once you reach the

minimum time (5 seconds) it restarts from the maximum time again.

The related indicator comes on  .

7.5 No softener

Press this button to exclude the softener load.



The related indicator comes on .

Press this button again, the softener is loaded normally.

The related indicator comes on .

7.6 Delay start

With this option you can delay the start of a programme from 30 minutes to 70 hours.



The display shows the related indicator  .

8. SETTINGS

8.1 Acoustic signals

The acoustic signals operate when:

- You activate the appliance.
- You select a programme.
- You deactivate the appliance.
- You press the buttons.
- The programme is completed.
- The appliance has a malfunction.





To **deactivate/activate** the acoustic signals, press  and  at the same time for 6 seconds.



If you deactivate the acoustic signals, they continue operate when the appliance has a malfunction.

8.2 Child Lock

With this option you can prevent that the children play with the control panel.

- To **activate/deactivate** this option, press  and  at the same time until the related indicator comes on in the display:
 - : Child lock activated.
 - : Child lock deactivated.

You can activate this option:



- After you press Start/Pause : the options and the programme knob are locked.
- Before you press Start/Pause : the appliance cannot start.



If the appliance is connected to coin operated machine, the child lock activates automatically 5 minutes after the programme start.

8.3 Permanent Extra Rinse

With this option you can permanently have an extra rinse when you set a new programme.

- To **activate/deactivate** this option press  and  at the same time until
+
the indicator  **comes on/goes off.**

9. DAILY USE



WARNING!

Refer to Safety chapters.

9.1 Loading the laundry

1. Pull the handle to open the appliance door
2. Put the laundry in the drum, one item at a time.
3. Shake the items before you put them in the appliance.

Make sure not to put too much laundry in the drum.

4. Close the door.

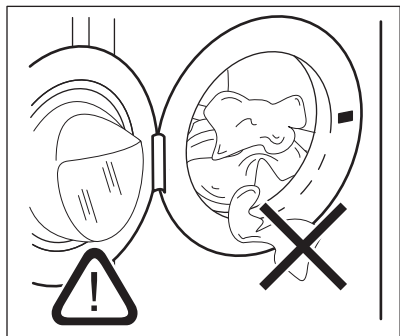

CAUTION!

Make sure that no laundry stays between the seal and the door. There is a risk of water leakage or damage to the laundry.

9.2 Installing the flap for liquid detergent

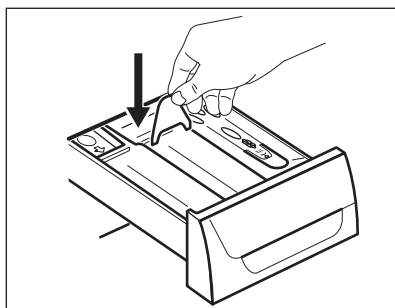

- Open the detergent dispenser.
- Install the flap for liquid detergent in the compartment .

9.3 Using detergent and additives

1. Measure out the detergent and the fabric conditioner.
2. Put the detergent and the fabric conditioner into the compartments.
3. Carefully close the detergent drawer

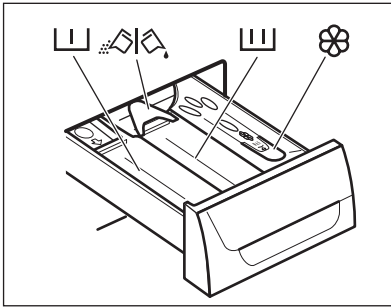

9.4 Detergent compartments







CAUTION!

Use only specified detergents for washing machine.



Always obey the instructions that you find on the packaging of the detergent products.

| | |
|---|--|
|  | Detergent compartment for prewash phase. |
|  | Detergent compartment for washing phase. |
|  | Compartment for liquid additives (fabric conditioner, starch). |
|  | Flap for powder or liquid detergent. |

9.5 Liquid or powder detergent

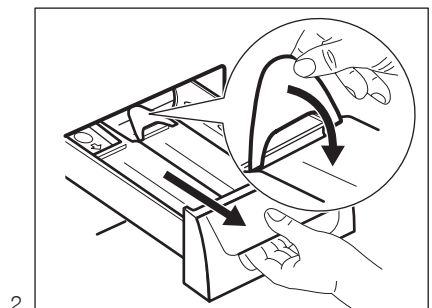
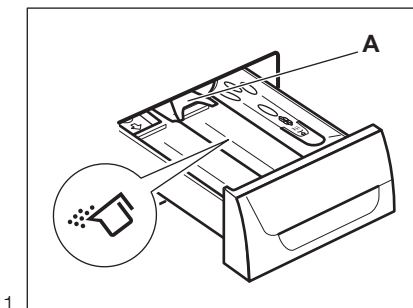

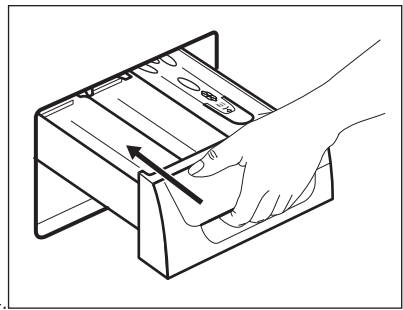
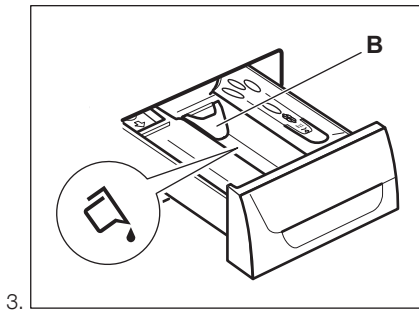

3. Position **A** for powder detergent (factory setting).
 • Position **B** for liquid detergent.



When you use the liquid detergent:

- Do not use gelatinous or thick liquid detergents.
- Do not put more liquid than the maximum level.
- Do not set the prewash phase.
- Do not set the delay start.

9.6 Activating the appliance

Press the button ① to activate the appliance. A tune sounds (if it is activated).

9.7 Setting a programme

1. Turn the programme knob and set the programme:
 - The related programme indicator comes on. A tune sounds (if it is activated).
 - The indicator of button Start/Pause flashes.
 - The display shows the programme duration and the indicators of the programme phases.
2. If necessary, change the spin time and add the available options. When you activate an option, the indicator of the set option comes on.



If you set something incorrect, the display shows the message **E r r r**.

9.8 Coin operated machine

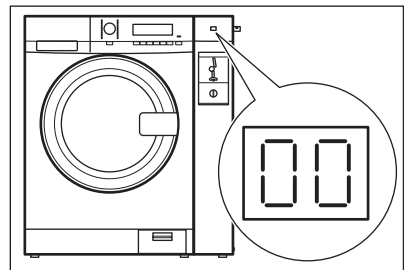

Insert correct amount of coins. When inserting coins, the display on the coin meter counts down to "00" (then it shows -- or **00**) and the appliance is ready to start.

Press button Start/Pause to start the appliance.



The display shows the message **E r r r** if the washing cycle has not been paid yet.

9.9 Starting a programme without the delay start

Press Start/Pause .

- The indicator of Start/Pause stops to flash and stays on.
- The indicator of the running phase starts to flash on the display.
- The programme starts the door locks.

i After approximately 15 minutes from the start of the programme:

- The appliance adjusts automatically the programme duration agree with the laundry load.
- The display shows the new value.

9.10 Starting a programme with the delay start

1. Press Delay start repeatedly until the display shows the delay you want to set.

The related indicator comes on the display



2. Press Start/Pause :
 - The appliance starts the countdown.
 - When the countdown is completed, the programme starts automatically.

i You can cancel or change the set of the delay start before you press Start/Pause. To cancel the delay start:

- Press Start/Pause to set the appliance to pause.
- Press Delay start until the display shows .
- Press Start/Pause again to start the programme immediately.

9.11 Cancelling the delay start

To cancel the delay start:

1. Press button Start/Pause to set the appliance to pause.

The related indicator flashes.

2. Press button Delay start repeatedly until the display shows .
3. Press button Start/Pause again to start the programme immediately.

9.12 Interrupting a programme and changing the options

You can change only some options before they operate.

1. Press Start/Pause . The indicator flashes.
2. Change the options.
3. Press Start/Pause again. The programme continues.

i If the appliance is connected to a coin operated machine, you can interrupt a programme only 5 minutes after the programme start. After this time the child lock automatically activates.

9.13 Cancelling a running programme



1. Press the button for some seconds to cancel the programme and to deactivate the appliance.
2. Press the same button again to activate the appliance. Now, you can set a new washing programme.

i Before starting the new programme the appliance could drain the water. In this case, make sure that the detergent is still in the detergent compartment, if not fill the detergent again.

i If the appliance is connected to a coin operated machine, you can cancel a programme only 5 minutes after the programme start. After this time the child lock automatically activates.



9.14 At the end of the programme

- The appliance stops automatically.

- A tune sounds (if it is activated).
- In the display  comes on.
- The indicator of button Start/Pause goes off.
- The door unlocks.
- You can open the door.
- Remove the laundry from the appliance. Make sure that the drum is empty.
- Close the water tap.
- Press the button  for some seconds to deactivate the appliance.
- Keep the door ajar, to prevent the mildew and odours.

9.15 AUTO OFF option

The AUTO OFF option automatically deactivates the appliance to decrease the energy consumption when:

- You do not use the appliance for 5 minutes before you press Start/Pause. Press the button  to activate the appliance again.
- After 5 minutes from the end of the washing programme Press the button  to activate the appliance again. The display shows the end of the last set programme. Turn the programme knob to set a new cycle.

10. HINTS AND TIPS



WARNING!

Refer to Safety chapters.

10.1 The laundry load

- Divide the laundry in: white, coloured, synthetics, delicates and wool.
- Obey the washing instructions that are on the laundry care labels.
- Do not wash together white and coloured items.
- Some coloured items can discolour with the first wash. We recommend that you wash them separately for the first times.
- Button up pillowcases, close zippers, hooks and poppers. Tie up belts.
- Empty the pockets and unfold the items.
- Turn inside out multilayered fabrics, wool and items with painted illustrations.
- Remove hard stains.
- Wash with a special detergent heavy soil stains.
- Be careful with the curtains. Remove the hooks or put the curtains in a washing bag or pillowcase.
- Do not wash in the appliance laundry without hems or with cuts. Use a washing bag to wash small and/or

delicate items (e.g. underwired bras, belts, tights, etc.).

- A very small load can cause balance problems with the spin phase. If this occurs, adjust manually the items in the tub and start the spin phase again.

10.2 Stubborn stains

For some stains, water and detergent is not sufficient.

We recommend that you remove these stains before you put the items in the appliance.

Special stain removers are available. Use the special stain remover that is applicable to the type of stain and fabric.

10.3 Detergents and additives

- Only use detergents and additives specially made for washing machines:
 - powder detergents for all types of fabric,
 - powder detergents for delicate fabrics (40 °C max) and woollens,
 - liquid detergents, preferably for low temperature wash programmes (60 °C max) for all types of fabric, or special for woollens only.

- Do not mix different types of detergents.
- To help the environment, do not use more than the correct quantity of detergent.
- Obey the instructions that you find on the on packaging of these products.
- Use the correct products for the type and colour of the fabric, the programme temperature and the level of soil.
- If your appliance has not the detergent dispenser with the flap device, add the liquid detergents with a dosing ball (supplied by the detergent's manufacturer).

10.4 Ecological hints

- Set a programme without the prewash phase to wash laundry with normal soil.
- Always start a washing programme with the maximum load of laundry.

- If necessary, use a stain remover when you set a programme with a low temperature.
- To use the correct quantity of the detergent, check the water hardness of your domestic system

10.5 Water hardness

If the water hardness in your area is high or moderate, we recommend that you use a water softener for washing machines. In areas where the water hardness is soft it is not necessary to use a water softener.

To know the water hardness in your area, contact your local water authority.

Use the correct quantity of the water softener. Obey the instructions that you find on the packaging of the product.

11. CARE AND CLEANING



WARNING!

Refer to Safety chapters.

11.1 External cleaning

Clean the appliance only with soap and warm water. Fully dry all the surfaces.



CAUTION!

Do not use alcohol, solvents or chemical products.

11.2 Descaling

If the water hardness in your area is high or moderate, we recommend that you use a water descaling product for washing machines.

Regularly examine the drum to prevent limescale and rust particles.

To remove rust particles use only special products for washing machine. Do this separately from the laundry wash.



Always obey the instructions that you find on the packaging of the product.

11.3 Maintenance wash

With the low temperature programmes it is possible that some detergent stays in the drum. Make regularly a maintenance wash. To do this:

- Remove the laundry from the drum.
- Set the cotton programme with the highest temperature with a small quantity of detergent.

11.4 Door seal

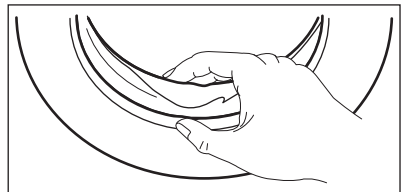

Regularly examine the seal and remove all objects from the inner part.

11.5 Cleaning the drum

Regularly examine the drum to prevent limescale and rust particles. Only use

special products to remove rust particles from the drum.

We suggest you to:

1. Clean the drum with special product for stainless steel.

2. Start a short programme for cotton at the maximum temperature with a small quantity of detergent.

11.6 Cleaning the detergent dispenser

1.

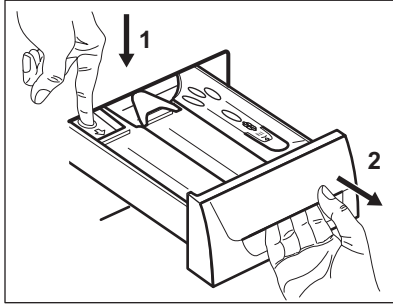

2.

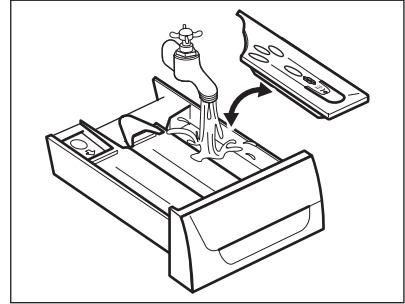

3.

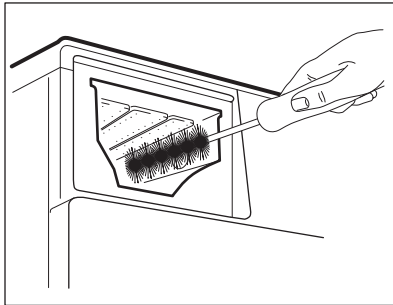

4.

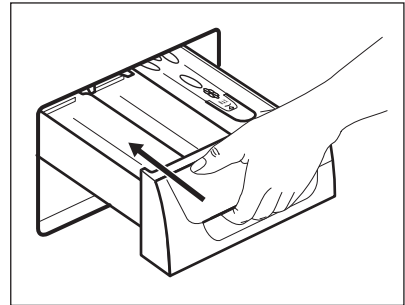

11.7 Cleaning the inlet hoses and the valve filters

Clean regularly both (for hot and for cold water) inlet hoses and both valve filters.

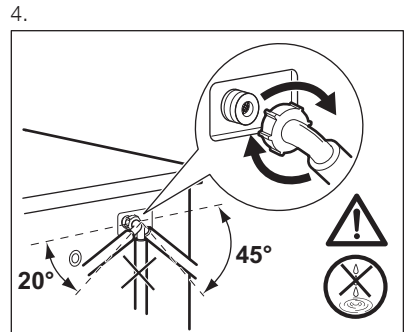
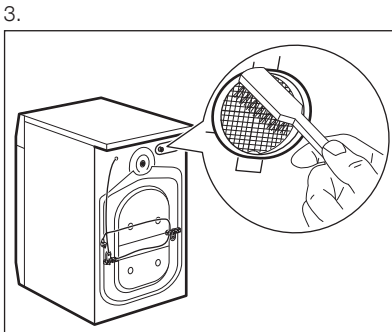
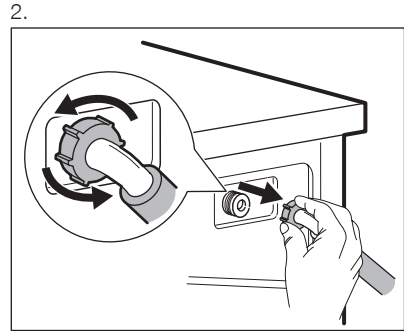
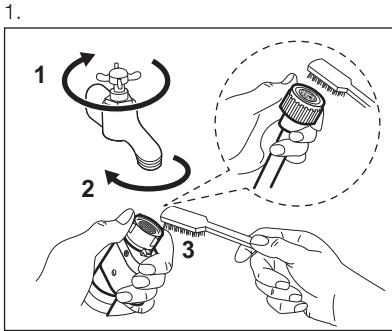

12. TROUBLESHOOTING

 **WARNING!**
Refer to Safety chapters.

12.1 Introduction

The start of the appliance does not occur or it stops during operation.

First try to find a solution to the problem (refer to the table). If not, contact the Authorised Service Centre.

With some problems, the acoustic signals operate and the display shows an alarm code:

- **E10** - The appliance does not fill with water properly.
- **E20** - The appliance does not drain the water.
- **E40** - The appliance door is open or not closed correctly. Please check the door!

- **E40** - The mains supply is unstable. Wait until the mains supply is stable.
- **E91** - No communication between electronic elements of the appliance. Switch off and switch on again.
- **EFD** - Detergent overdosing.
- **E90** -
 - Check the electrical connection first.
 - No communication with the coin operated machine or the coin operated machine doesn't work. Check the connection between coin meter and appliance first, if the problem is not solved, contact the Authorised Service Centre.
 - No communication with the external detergent dispenser. Check the connection between detergent dispenser and appliance first, if the problem is not solved, contact the Authorised Service Centre.

**WARNING!**

Deactivate the appliance before you do the checks.

12.2 Possible failures

| Problem | Possible solution |
|---|--|
| The programme does not start. | Make sure that the mains plug is connected to the mains socket. |
| | Make sure that the appliance door is closed. |
| | Make sure that there is not a damaged fuse in the fuse box. |
| | Make sure that the Start/Pause has been pressed. |
| | If the delay start is set, cancel the setting or wait for the end of countdown. |
| | Deactivate the Child Lock function if it is on. |
| The appliance does not fill with water properly. | Make sure that the water tap is open. |
| | Make sure that the pressure of the water supply is not too low. For this information, contact your local water authority. |
| | Make sure that the water tap is not clogged. |
| | Make sure that the filters of the inlet hoses and the filters of the valves are not clogged. Refer to "Care and cleaning". |
| | Make sure that the inlet hoses have no kinks or bends. |
| | Make sure that the connections of the water inlet hoses are correct. |
| The appliance does not drain the water. | Set the drain programme. |
| The spin phase does not operate or the washing cycle lasts longer than usually. | Set the spin programme. |
| | Adjust manually the items in the tub and start the spin phase again. This problem may be caused by balance problems. |
| There is water on the floor. | Make sure that the couplings of the water hoses are tight and there is not water leakages. |
| | Make sure you use the correct detergent and the correct quantity of it. |
| You cannot open the appliance door. | Make sure that the washing programme is finished. |

| Problem | Possible solution |
|---|--|
| | Set the drain or the spin programme if there is water in the drum. |
| | Make sure that the appliance receives electrical power. |
| | This problem may be caused by a failure of the appliance. Contact the Authorised Service Centre. If you need to open the door, please read carefully «Emergency door opening». |
| The appliance makes an unusual noise. | Make sure the levelling of the appliance is correct. Refer to 'Installation'. |
| | Make sure that the packaging and/or the transit bolts are removed. Refer to 'Installation'. |
| | Add more laundry in the drum. The load may be too small. |
| The cycle is shorter than the time displayed. | The appliance calculates a new time according to the laundry load. See the 'Consumption Values' chapter. |
| The cycle is longer than the time displayed. | An unbalanced laundry load increases the duration time. This is a normal behaviour of the appliance. |
| The washing results are not satisfactory. | Increase the detergent quantity or use a different detergent. |
| | Use special products to remove the stubborn stains before you wash the laundry. |
| | Make sure that you set the correct temperature. |
| | Decrease the laundry load. |
| You cannot set an option. | Make sure that you press only the wanted touch button(s). |
| The drum light does not go on. | Make sure that you activate the appliance. Refer to 'Daily Use'. |

After the check, activate the appliance. The programme continues from the point of interruption.

If the problem occurs again, contact the Authorised Service Centre.

If the display shows other alarm codes. Deactivate and activate the appliance. If the problem continues, contact the Authorised Service Centre.

13. EMERGENCY DOOR OPENING

In case of power failure or appliance failure the appliance door remains locked. The washing programme continues, when the power is restored. If the door remains locked in case of failure, it is possible to open it using the emergency unlock feature.

Before opening the door:



CAUTION!
Make sure that the water temperature and the laundry are not hot. Wait till they cool down, if necessary.



CAUTION!
Make sure that the drum is not rotating. Wait till the drum stops rotating, if necessary.



Make sure that the water level inside the drum is not too high. Proceed with an emergency drain, if necessary (refer to «Emergency drain» in «Care and cleaning» chapter).

To open the door, proceed as follows:

1. Press the button to switch the appliance off.
2. Disconnect the mains plug from the mains socket.

3. Open the filter flap.
4. Pull twice the emergency unlock trigger downward and open the appliance door.

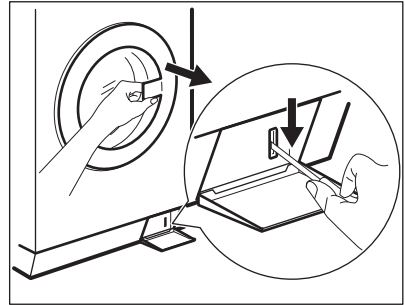

5. Take out the laundry and then close the appliance door.
6. Close the filter flap.

14. TECHNICAL DATA

| | | |
|--|---|---------------------------------------|
| Dimension | Width/ Height/ Depth/ Total depth | 600 mm/ 850 mm/ 605 mm/ 639 mm |
| Electrical connection | Voltage Overall power Fuse Frequency | 230 V 2200 W 10 A 60 Hz |
| Level of protection against ingress of solid particles and moisture ensured by the protective cover, except where the low voltage equipment has no protection against moisture | | IPX4 |
| Water supply pressure | Minimum Maximum | 0,5 bar (0,05 MPa) 8 bar (0,8 MPa) |
| Emission sound pressure level in accordance with EN ISO 11204/11203 | | < 70 dB |
| Water supply ¹⁾ | | Cold water Hot water ²⁾ |
| Maximum Load | Cotton | 8 kg |
| Energy Efficiency Class | | A+++ |
| Spin Speed | Maximum | 1400 rpm |

¹⁾ Connect the water inlet hose to a water tap with a 3/4" thread.

²⁾ Make sure that the hot water temperature of your domestic system is not more than 55 °C.

15. ENVIRONMENT CONCERNS

Recycle the materials with the symbol . Put the packaging in applicable containers to recycle it. Help protect the environment and human health and to recycle waste of electrical and electronic appliances. Do

not dispose appliances marked with the symbol  with the household waste. Return the product to your local recycling facility or contact your municipal office.

CE

132899290-A-172015



Electrolux Professional S.p.A.
Viale Treviso, 15 -33170 Pordenone
Italy

www.electrolux.com/myPRO

Share more of our thinking at
www.electrolux.com